

Foam tank for Tests in Spain July 2016

Ian Crotty

6 April 2016

(x 3-4) Vessel dia 800 mm

Height = 1000mm

Max weight of 12kg

Cone at Base

Handles x2 at top

Lifting hook at top.

Dia 800mm

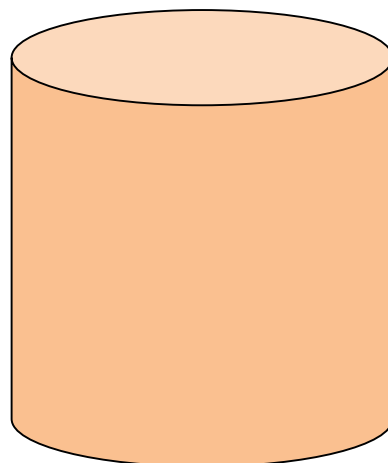

Height = 1100mm

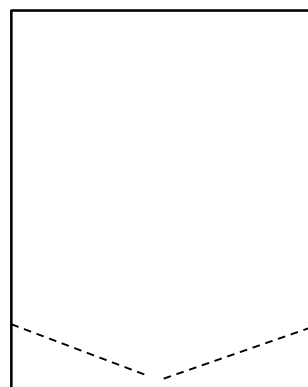

130mm

Drainage Hole dia 10mm

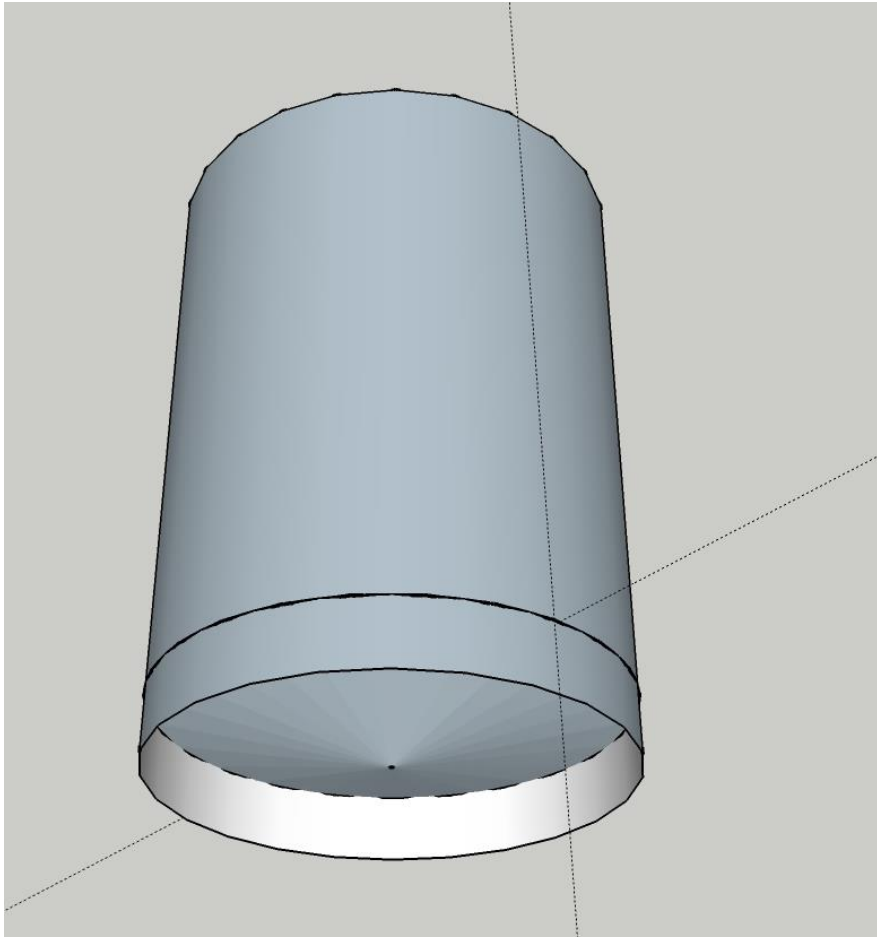

Calculate cone

http://craig-russell.co.uk/demos/cone_calculator/

Craig Russell Blog

Calculates the measurements for the pattern to construct a flat top cone.

Length A

(mm)

Length B

(mm)

Length C

(mm)

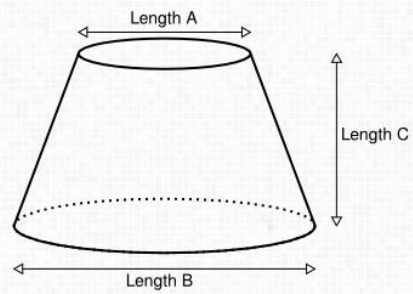

Arc Angle = 348.99 (degrees)

Radius R1 = 5.16 (mm)

Radius R2 = 412.62 (mm)

